

- > Ø 32 ... 100 mm
- > High performance, stability and reliability
- > M/50 switches (solid state) can be mounted flush with the profile
- > Cylinders and mountings conform to ISO 15552
- > (ISO 6431, VDMA 24562 and NFE 49-003-1)
- > Comprehensive range of mountings
- > Polyurethane seals ensure efficient low friction operation and long life

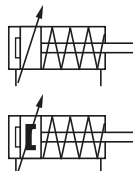

Technical features

Medium:

Compressed air, filtered, lubricated or non-lubricated

Standard:

ISO 15552

Note: all models conform to the mentioned standards except the cylinder size

Operation:

PRA/181000: Single acting, sprung in, non-magnetic piston and adjustable cushioning

PRA/181000/M: Single acting, sprung in, magnetic piston and adjustable cushioning

PRA/183000: Single acting, sprung out, non-magnetic piston and adjustable cushioning

PRA/183000/M: Single acting, sprung out, magnetic piston and adjustable cushioning

Operating pressure:

2 ... 10 bar (29 ... 145 psi)

Ports:

G1/8 ... G1/2

Cylinder diameters:

32, 40, 50, 63, 80, 100 mm

Strokes:

See page below

Non-standard strokes:

Available 250 mm max.

Operating temperature:

-20 ... +80°C max. (-4 ... +176 °F)

Air supply must be dry enough to avoid ice formation at temperatures below +2°C (+35°F).

Materials:

Profile barrel:

anodised aluminium, End covers: pressure diecast aluminium

Piston rod: stainless steel (martensitic)

Piston rod seals: PUR

Piston seals: PUR

O-rings: NBR

Technical data

Cylinder Ø (mm)	32	40	50	63	80	100
Port size	G 1/8	G 1/4	G 1/4	G 3/8	G 3/8	G 1/2
Piston rod Ø (mm)	12	16	20	20	25	25
Piston rod thread	M10 x 1,25	M12 x 1,25	M16 x 1,5	M16 x 1,5	M20 x 1,5	M20 x 1,5
Cushion length (mm)	19	22	24	24	27	34
Initial cushion volume (cm ³)	12,3	20,7	36	64	116	242
Air consumption at 6 bar outstroke (l/cm)	0,056	0,088	0,137	0,218	0,35	0,55
Air consumption at 6 bar instroke (l/cm)	0,048	0,074	0,114	0,195	0,32	0,51
PRA/181000/M, PRA/181000						
Theoretical thrusts at 6 bar outstroke (N)	392	648	1043	1735	2795	4492
F1 (N)	50	60	75	75	130	130
PRA/183000/M, PRA/183000						
Theoretical thrusts at 6 bar instroke (N)	324	528	854	1546	2501	4197
F1 (N)	50	60	75	75	130	130

F1 = Final return force of spring

Standard strokes

Cylinder Ø (mm)	Stroke length (mm)			
	25	50	80	100
32	•	•	•	•
40	•	•	•	•
50	•	•	•	•
63	•	•	•	•
80	•	•	•	•
100	•	•	•	•

Cylinder variants

Symbol	Model Non-magnetic piston		Symbol	Model magnetic piston		Description	Dimensions Page
	C	S		C	S		
	•	•		•	•	Standard cylinder, sprung in	4
						Cylinder with special wiper/seal, suitable for applications with arizona sand, cement, plaster (stucco), hoar-frost or ice	
						Cylinder with non-rotating piston rod	5
	•	•		•	•	Standard cylinder, sprung out	4
						Cylinder with special wiper/seal, suitable for applications with arizona sand, cement, plaster (stucco), hoar-frost or ice	
						Cylinder with non-rotating piston rod	4

For the cylinder models style C and S see options selector

Option selector

P★A/18★★★★/★/★

Piston rod material	Substitute	←	→	Strokes (mm)	
Stainless steel martensitic	R			250 max.	
Hard chromium plated	C			Variants (magnetic piston)	Substitute
Stainless steel austenitic	S			Standard	M
Operation	Substitute	←	→	Non-rotating piston rod	N2
Sprung in	1			Special wiper/seal	W2
Sprung out	3			Variants (non-magnetic piston)	Substitute
Cylinder Ø	Substitute	←	→	Standard	None
32	032			Non-rotating piston rod	N1
40	040			Special wiper/seal	W1
50	050				
63	063				
80	080				
100	100				





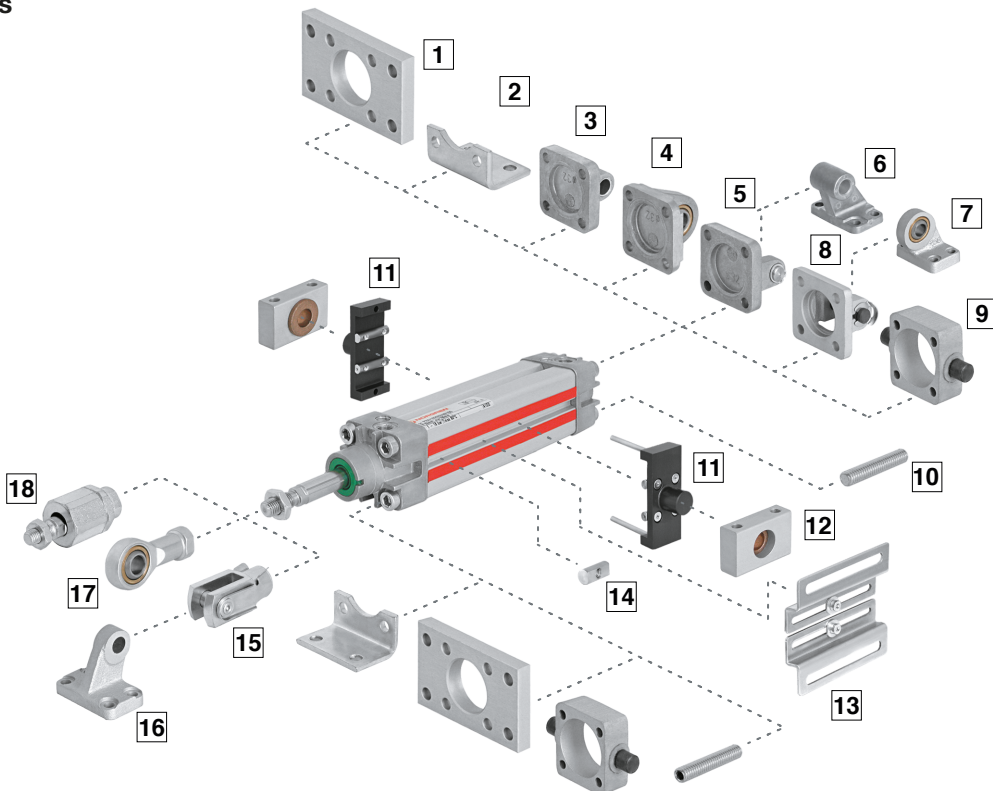











Note: If option is not required, disregard option position within part number eg. PRA/18100/M/50. For combinations of cylinder variants consult our Technical Service. This options selector explains only the cylinder variants. Additional variants/options are not possible.

Mountings







Position	Style	Standard	Position	Style	Standard
1	B, G	Clear anodised aluminium	10	A	Galvanized steel
2	C	Galvanized steel (ø 32 ... 63 mm), Painted steel (ø 80 & 100 mm)	11	UH	Black anodised aluminium bar stock Groove key and bolt: Galvanized steel
3	R	Die-cast aluminium	12	S	Clear anodised aluminium Bearing: brass
4	UR	Galvanized aluminium Inner ring: steel Outer ring: brass	13	Valve mounting kit	Galvanized steel
5	D	Die-cast aluminium Bolt: galvanized steel (martensitic) Circlip: galvanized steel	15	F	Galvanized steel Bolt: galvanized steel Circlip: Galvanized steel
6	SW	Die-cast aluminium	16	SS	Painted cast iron
7	US	Galvanized aluminium. Inner ring: steel Outer ring: brass	17	UF	Galvanized steel. Inner ring: steel Outer ring: brass
8	D2	Painted cast iron. Bolt: stainless steel (martensitic) Circlip: galvanized steel	18	AK	Galvanized steel
9	FH	Cast iron			

Mountings

Model	A	AK	B, G	C	D	D2	F	FH
								
Cyl. Ø	10 Page 5	18 Page 5	1 Page 5	2 Page 5	5 Page 6	8 Page 6	15 Page 6	9 Page 6
32	QM/8032/35	QM/8025/38	QA/8032/22	QA/8032/21	QA/8032/23	QA/8032/42	QM/8025/25	QA/8032/34
40	QM/8032/35	QM/8040/38	QA/8040/22	QA/8040/21	QA/8040/23	QA/8040/42	QM/8040/25	QA/8040/34
50	QM/8050/35	QM/8050/38	QA/8050/22	QA/8050/21	QA/8050/23	QA/8050/42	QM/8050/25	QA/8050/34
63	QM/8050/35	QM/8050/38	QA/8063/22	QA/8063/21	QA/8063/23	QA/8063/42	QM/8050/25	QA/8063/34
80	QM/8080/35	QM/8080/38	QA/8080/22	QA/8080/21	QA/8080/23	QA/8080/42	QM/8080/25	QA/8080/34
100	QM/8080/35	QM/8080/38	QA/8100/22	QA/8100/21	QA/8100/23	QA/8100/42	QM/8080/25	QA/8100/34
	R	S	SS	SW	UF	UH	UR	US
								
Cyl. Ø	3 Page 7	12 Page 6	16 Page 8	6 Page 8	17 Page 6	11 Page 7	4 Page 7	7 Page 8
32	QA/8032/27	QA/8032/41	M/P19931	M/P19493	QM/8025/32	PQA/182032/40	QA/8032/33	M/P40310
40	QA/8040/27	QA/8040/41	M/P19932	M/P19494	QM/8040/32	PQA/182040/40	QA/8040/33	M/P40311
50	QA/8050/27	QA/8040/41	M/P19933	M/P19495	QM/8050/32	PQA/182050/40	QA/8050/33	M/P40312
63	QA/8063/27	QA/8063/41	M/P19934	M/P19496	QM/8050/32	PQA/182063/40	QA/8063/33	M/P40313
80	QA/8080/27	QA/8063/41	M/P19935	M/P19497	QM/8080/32	PQA/182080/40	QA/8080/33	M/P40314
100	QA/8100/27	QA/8100/41	M/P19936	M/P19498	QM/8080/32	PQA/182100/40	QA/8100/33	M/P40315

Accessories

	Groove cover	M/50/**	Groove key	Valve mounting kit
				
Cyl. Ø	Page 9	Page 10 & 11	14 Page 9	13 Page 9
32	M/P72725/1000		M/P72816	–
40	M/P72725/1000		M/P72816	–
50	M/P72725/1000		M/P72816	QA/180050/22/54
63	M/P72725/1000		M/P72816	QA/180050/22/54
80	M/P72725/1000		M/P72816	QA/180080/22/54
100	M/P72725/1000		M/P72816	QA/180080/22/54

Service kit

	Service Kit
	
Cyl. Ø	Page 9
32	QA/8032/00
40	QA/8040/00
50	QA/8050/00
63	QA/8063/00
80	QA/8080/00
100	QA/8100/00

Basic dimensions
PRA/181000, PRA/181000/M
Standard cylinder
Sprung in

PRA/183000, PRA/183000/M
Standard cylinder
Sprung out

Dimensions in mm
Projection/First angle

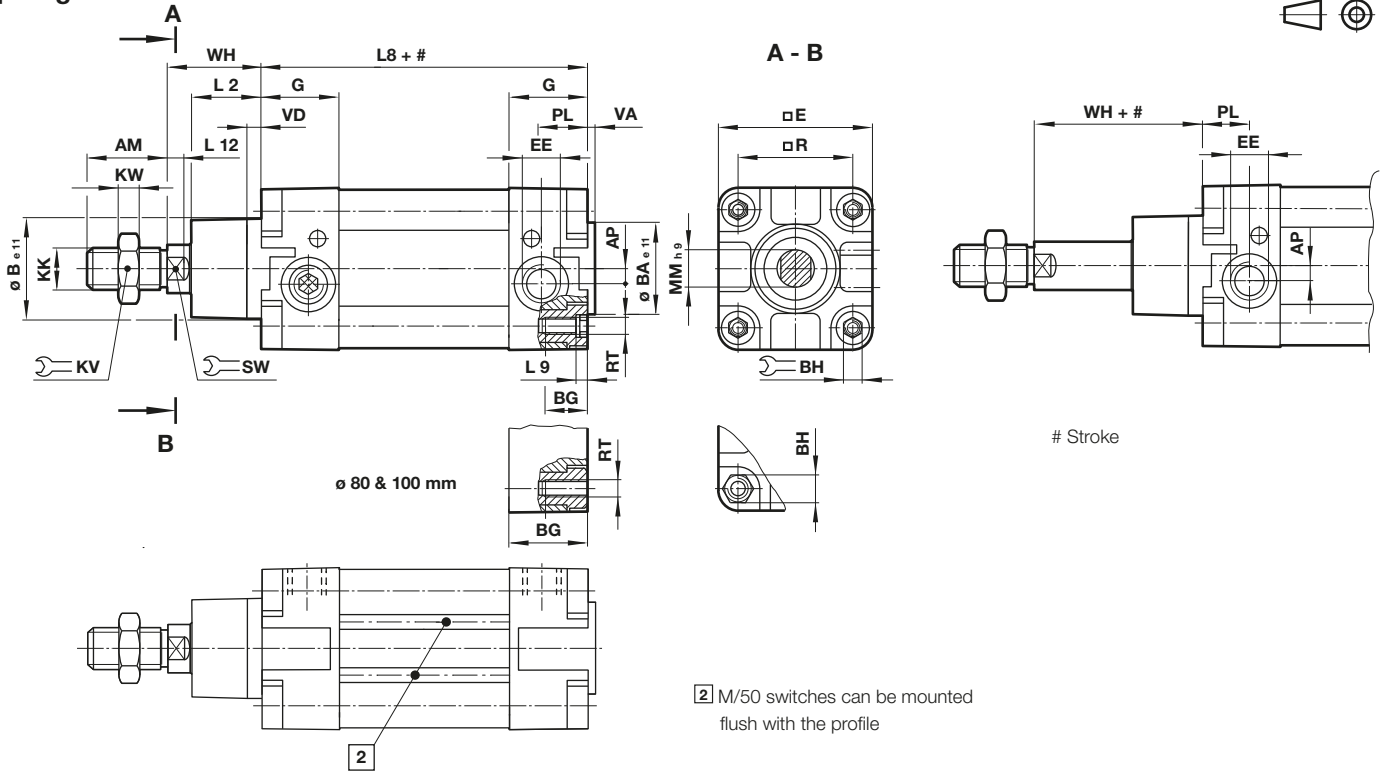

2 M/50 switches can be mounted flush with the profile

Ø	AM	AP	Ø Be11	Ø BAe11	BG	BH	Ø E	EE	G	KK	KV
32	22	3,5	30	30	16	6	47	G 1/8	27,5	M10x1,25	17
40	24	4,5	35	35	16	6	53	G 1/4	32	M12x1,25	19
50	32	6	40	40	16	8	65	G 1/4	31	M16x1,5	24
63	32	10	45	45	16	8	75	G 3/8	33	M16x1,5	24
80	40	8,5	45	45	17	19	95	G 3/8	33	M20x1,5	30
100	40	9	55	55	17	19	115	G 1/2	37	M20x1,5	30
Ø	KW	L2	L8	L9	L12	Ø MM h9	PL	Ø R	RT	SW	VA
32	5	20	94	4	6	12	13	32,5	M 6	10	3
40	6	22	105	4	6,5	16	15	38	M 6	13	3,5
50	8	27	106	5	8	20	18,5	46,5	M 8	17	3,5
63	8	29	121	5	8	20	19	56,5	M 8	17	4
80	10	33	128	-	10	25	19	72	M 10	22	4
100	10	36	138	-	10	25	18	89	M 10	22	4
Ø	VD	WH	at 0 mm		per 25 mm		Model Non-magnetic piston		Model Magnetic piston		
32	6	26	0,51 kg		0,06 kg		PRA/18#032/*		PRA/18#032/M/*		
40	6	30	0,80 kg		0,08 kg		PRA/18#040/*		PRA/18#040/M/*		
50	6	37	1,33 kg		0,12 kg		PRA/18#050/*		PRA/18#050/M/*		
63	6	37	1,80 kg		0,13 kg		PRA/18#063/*		PRA/18#063/M/*		
80	6	46	3,25 kg		0,20 kg		PRA/18#080/*		PRA/18#080/M/*		
100	6	51	4,81 kg		0,23 kg		PRA/18#100/*		PRA/18#100/M/*		

181032	183032	181040	183040	181050	183050	181063	183063	181080	183080	181100	183100	Model
25, 50	80, 100	25, 50	80, 100	25, 50	80, 100	25, 50	80, 100	25, 50	80, 100	25, 50	80, 100	Standard strokes
119	147	130	158	131	159	146	174	153	181	163	191	L8
119 + (N * x 28)	130 + (N * x 28)	131 + (N * x 28)	146 + (N * x 28)	153 + (N * x 28)	163 + (N * x 28)							L8
250 mm max.												non-standard strokes

* Stroke < 50 mm N = 0
Stroke > 50 mm N = $\frac{\text{Stroke} - 1}{50}$ (round up to integer)

Please insert number of spring in (1) or spring out (3).

Cylinder variants

PRA/18.000/N1, PRA/18.000/N2 – Cylinder with non-rotating piston rod

Dimensions in mm
Projection/First angle

Ø		max. Torque (Nm)	Model non-magnetic piston	Model magnetic piston
32	10	0,5	PRA/18#032/N1/*	PRA/18#032/N2/*
40	13	1	PRA/18#040/N1/*	PRA/18#040/N2/*
50	16	1,5	PRA/18#050/N1/*	PRA/18#050/N2/*
63	16	1,5	PRA/18#063/N1/*	PRA/18#063/N2/*
80	16	2,5	PRA/18#080/N1/*	PRA/18#080/N2/*
100	21	2,5	PRA/18#100/N1/*	PRA/18#100/N2/*

* Please insert standard stroke length.

Please insert number of spring in (1) or spring out (3).

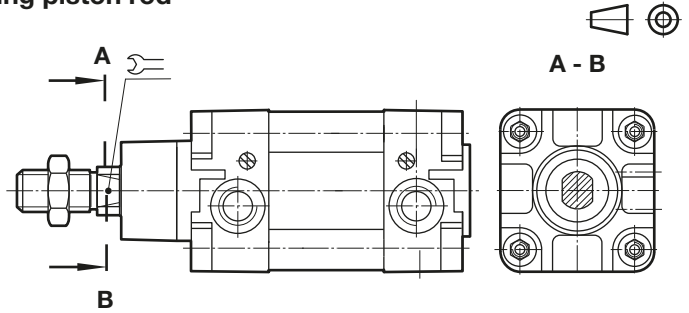

Mountings

Front or rear stud mounting A

Conforms to ISO 15552, type MX1

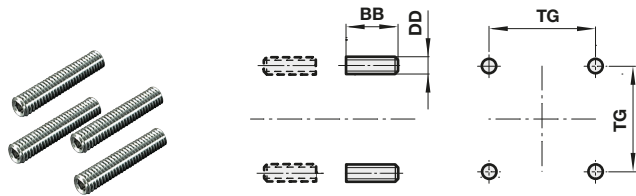

Ø	BB	DD	TG	kg	Model (A)
32/40	17	M6	32,5/38	0,02	QM/8032/35
50/63	23	M8	46,5/56,5	0,05	QM/8050/35
80/100	28	M10	72/89	0,08	QM/8080/35

Piston rod swivel AK

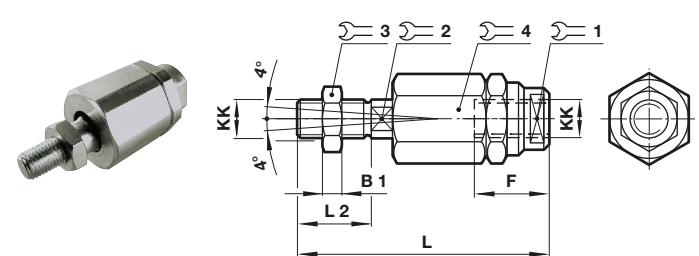

Ø	KK	B1	F	L	L2					kg	Model (AK)
						1	2	3	4		
32	M10x1,25	5	26	73	20	19	12	17	30	0,20	QM/8025/38
40	M12x1,25	6	26	77	24	19	12	19	30	0,20	QM/8040/38
50/63	M16x1,5	8	34	106	32	30	19	24	42	0,65	QM/8050/38
80/100	M20x1,5	10	42	122	40	30	19	30	42	0,72	QM/8080/38

Front flange B, G

Conforms to ISO 15552, type MF1 and MF2

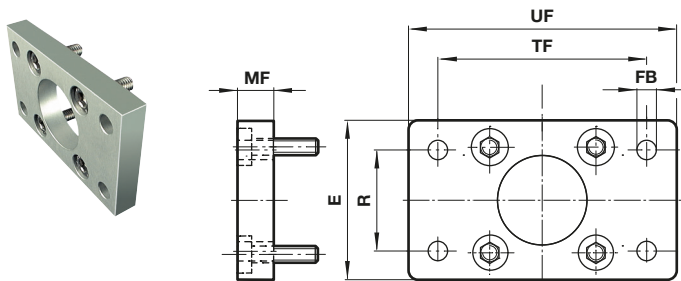

Ø	E	Ø FB	MF	R	TF	UF	kg	Model (B, G)
32	50	7	10	32	64	80	0,25	QA/8032/22
40	55	9	10	36	72	90	0,35	QA/8040/22
50	65	9	12	45	90	110	0,70	QA/8050/22
63	75	9	12	50	100	125	0,80	QA/8063/22
80	100	12	16	63	126	154	1,35	QA/8080/22
100	120	14	16	75	150	186	2,20	QA/8100/22

Foot mounting C

Conforms to ISO 15552, type MS1

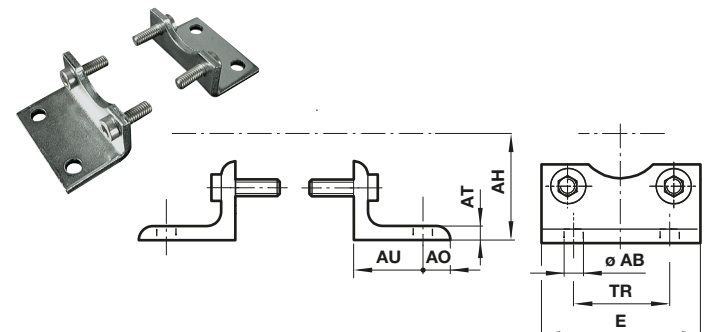

Ø	Ø AB	AH	AO	AT	AU	E	TR	kg	Model (C)
32	7	32	8	4	24	48	32	0,15	QA/8032/21
40	10	36	9	4	28	53	36	0,18	QA/8040/21
50	10	45	10	5	32	64	45	0,30	QA/8050/21
63	10	50	12	5	32	74	50	0,39	QA/8063/21
80	12	63	19	5	41	98	63	0,80	QA/8080/21
100	14	71	19	5	41	115	75	0,95	QA/8100/21

Rear clevis D
Conforms to ISO 15552, type MP2

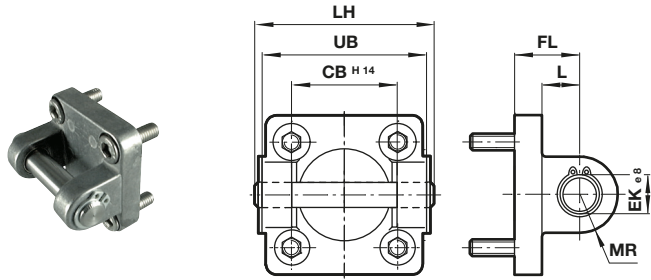

Ø	CB H14	Ø EK e8	FL	L	LH	MR	UB	kg	Model (D)
32	26	10	22	13	52	9	45	0,11	QA/8032/23
40	28	12	25	16	60	12	52	0,16	QA/8040/23
50	32	12	27	17	68	12	60	0,22	QA/8050/23
63	40	16	32	22	79	15	70	0,34	QA/8063/23
80	50	16	36	22	99	15	90	0,54	QA/8080/23
100	60	20	41	27	119	20	110	0,90	QA/8100/23

Rear clevis D2
Conforms to ISO 15552, type AB6

Dimensions in mm
Projection/First angle

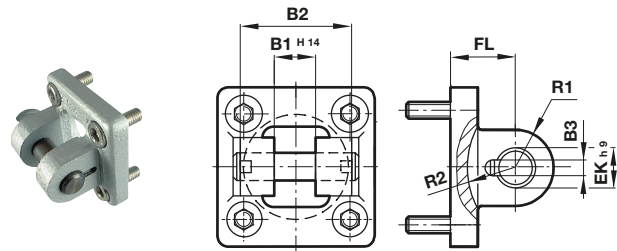

Ø	B1 H14	B2	B3	Ø EK h9	FL	R1	R2	kg	Model (D2)
32	14	34	3,3	10	22	11	17	0,20	QA/8032/42
40	16	40	4,3	12	25	12	20	0,23	QA/8040/42
50	21	45	4,3	16	27	14,5	22	0,36	QA/8050/42
63	21	51	4,3	16	32	18	25	0,55	QA/8063/42
80	25	65	4,3	20	36	22	30	0,90	QA/8080/42
100	25	75	4,3	20	41	22	32	1,45	QA/8100/42

Piston rod clevis F
Conforms to DIN ISO 8140

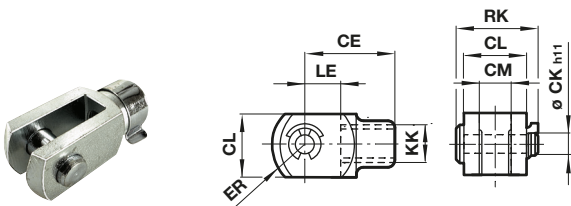

Ø	KK	CE	Ø CK h11	CL	CM	ER	LE	RK	kg	Model (F)
32	M10x1,25	40	10	20	10	16	20	28	0,09	QM/8025/25
40	M12x1,25	48	12	24	12	19	24	32	0,13	QM/8040/25
50/63	M16x1,5	64	16	32	16	25	32	41,5	0,33	QM/8050/25
80/100	M20x1,5	80	20	40	20	32	40	50	0,67	QM/8080/25

Front or rear detachable trunnion FH
Conforms to VDMA 24562 part 2, type MT 5/6

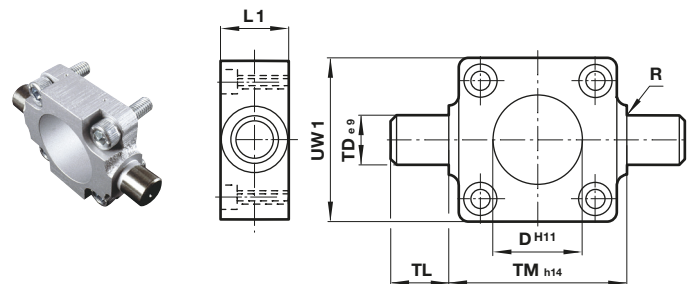

Ø	Ø D h11	L1	R	Ø TD e9	TL	TM h14	UW1	kg	Model (FH)
32	30	16	1	12	12	50	45	0,20	QA/8032/34
40	35	20	1,6	16	16	63	55	0,38	QA/8040/34
50	40	24	1,6	16	16	75	65	0,60	QA/8050/34
63	45	24	1,6	20	20	90	75	1,10	QA/8063/34
80	45	28	1,6	20	20	110	100	1,90	QA/8080/34
100	55	38	2	25	25	132	120	3,50	QA/8100/34

Trunnion support S
Conforms to ISO 15552, type AT4

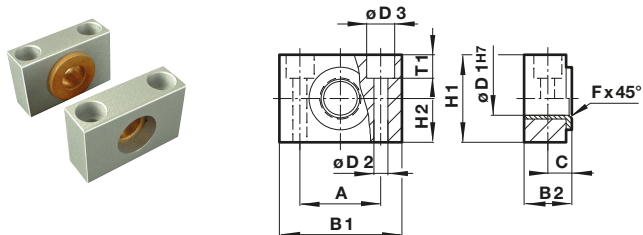

Ø	A	B	C	Ø D1 H7	Ø D2	Ø D3	F x 45°	H	T1	kg	Model (S)	
32	32	46	18	10,5	12	6,6	11	1	30	15	6,8	QA/8032/41
40/50	36	55	21	12	16	9	15	1,6	36	18	9	QA/8040/41
63/80	42	65	23	13	20	11	18	1,6	40	20	11	QA/8063/41
100	50	75	28,5	16	25	14	20	2	50	25	13	QA/8100/41

Universal piston rod eye UF
Conforms to DIN ISO 8139

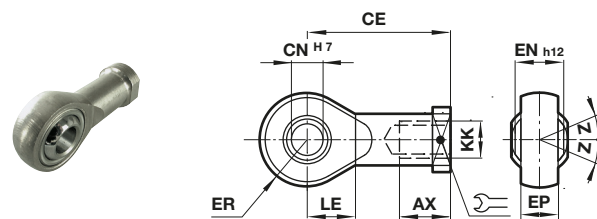

Ø	Thread KK	AX	CE	Ø CN H7	EN -0,1	ER	LE	Z	kg	Model (UF)
32	M10x1,25	20	43	10	14	14	15	13°	0,09	QM/8025/32
40	M12x1,25	22	50	12	16	16	17	13°	0,13	QM/8040/32
50/63	M16x1,5	28	64	16	21	21	22	15°	0,33	QM/8050/32
80/100	M20x1,5	33	77	20	25	25	26	15°	0,67	QM/8080/32

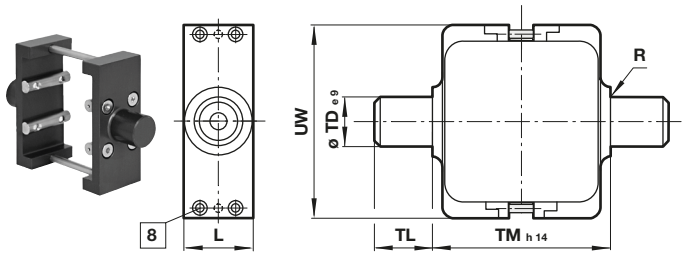
**Adjustable trunnion mounting UH
Conforms to ISO 15552, type MT4**

8 Locking screw

Ø	L	R	Ø TD e9	TL	TM h14	UW	Torque max. (Nm)	kg	Model (UH)
32	25	1	12	12	50	58	2	0,16	PQA/182032/40
40	28	1,6	16	16	63	65	3,5	0,35	PQA/182040/40
50	28	1,6	16	16	75	80	3,5	0,65	PQA/182050/40
63	36	1,6	20	20	90	96	5	0,85	PQA/182063/40
80	36	1,6	20	20	110	116	6	1,2	PQA/182080/40
100	48	2	25	25	132	140	6	2,3	PQA/182100/40

Style 'UH': It is most important that the locking screws which secure the mounting to the tie rod are tightened to the torque figures shown in the table below.
For maximum energy input, consult our Technical Service.

**Rear eye R
Conforms to ISO 15552, type MP4**

Dimensions in mm
Projection/First angle

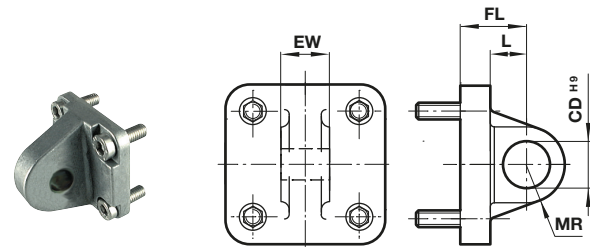

Ø	Ø CD H9	EW	FL	L	MR	kg	Model (R)
32	10	25,8	22	13	9	0,09	QA/8032/27
40	12	27,8	25	16	12	0,11	QA/8040/27
50	12	31,7	27	17	12	0,17	QA/8050/27
63	16	39,7	32	22	15	0,24	QA/8063/27
80	16	49,7	36	22	15	0,37	QA/8080/27
100	20	59,7	41	27	20	0,59	QA/8100/27

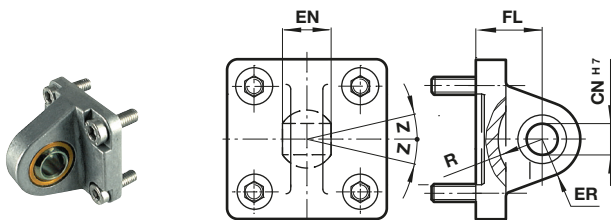
**Universal rear eye UR
Conforms to ISO 15552, type MP6**

Ø	Ø CN H7	EN	ER	FL	R	Z	kg	Model (UR)
32	10	14	16	22	14,5	13°	0,15	QA/8032/33
40	12	16	18	25	18	13°	0,25	QA/8040/33
50	16	21	21	27	19	15°	0,40	QA/8050/33
63	16	21	23	32	24	15°	0,55	QA/8063/33
80	20	25	28	36	24	15°	0,90	QA/8080/33
100	20	25	30	41	29	15°	1,50	QA/8100/33

Wide hinge SW
Conforms to ISO 15552, type AB7

Dimensions in mm
Projection/First angle

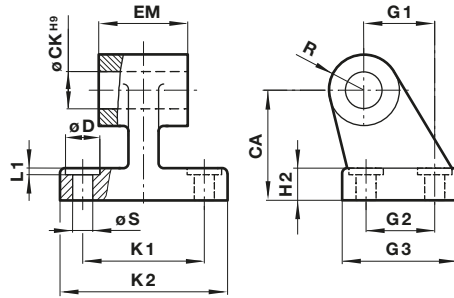

Ø	CA	Ø CK H9	Ø D	H2	EM	G1	G2	G3	K1	K2	L1	R	Ø S	kg	Model (SW)
32	32	10	11	7	25,5	21	18	31	38	50	1,6	10	6,6	0,05	MP19493
40	36	12	11	9	27,5	24	22	35	41	54	1,6	11	6,6	0,07	MP19494
50	45	12	15	11	31,5	33	30	45	50	65	1,6	13	9	0,14	MP19495
63	50	16	15	12	39,5	37	35	50	52	67	1,6	15	9	0,18	MP19496
80	63	16	18	14	49,5	47	40	60	66	84	2,5	15	11	0,28	MP19497
100	71	20	18	15	59,5	55	50	70	76	94	2,5	19	11	0,42	MP19498

Narrow hinge SS

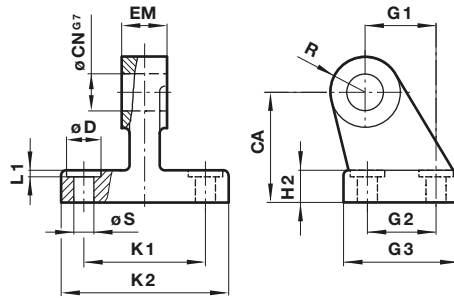

Ø	CA	Ø CN G7	Ø D	H2	EM	G1	G2	G3	K1	K2	L1	R	Ø S	kg	Model (SS)
32	32	10	11	8	10	21	18	31	38	51	1,6	10	6,6	0,15	MP19931
40	36	12	11	10	12	24	22	35	41	54	1,6	11	6,6	0,20	MP19932
50	45	16	15	12	16	33	30	45	50	65	1,6	13	9	0,48	MP19933
63	50	16	15	12	16	37	35	50	52	67	1,6	15	9	0,50	MP19934
80	63	20	18	14	20	47	40	60	66	86	2,5	15	11	0,75	MP19935
100	71	20	18	15	20	55	50	70	76	96	2,5	19	11	1,20	MP19936

Swivel hinge US
Conforms to VDMA 24562 part 2

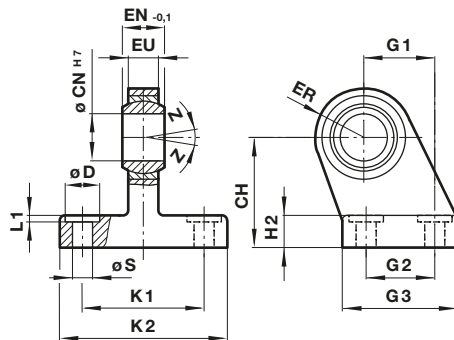

Ø	CH	Ø CN H7	Ø D	EN -0,1	ER	EU	G1	G2	G3	H2	K1	K2	L1	Ø S	Z	kg	Model (US)
32	32	10	11	14	16	10,5	21	18	31	10	38	51	1,6	6,6	13°	0,19	MP40310
40	36	12	11	16	18	12	24	22	35	10	41	54	1,6	6,6	13°	0,24	MP40311
50	45	16	15	21	21	15	33	30	45	12	50	65	1,6	9	13°	0,46	MP40312
63	50	16	15	21	23	15	37	35	50	12	52	67	1,6	9	15°	0,59	MP40313
80	63	20	18	25	28	18	47	40	60	14	66	86	2,5	11	15°	1,03	MP40314
100	71	20	18	25	30	18	55	50	70	15	76	96	2,5	11	15°	1,40	MP40315

Groove key M/P72816
Weight: 0,01 kg

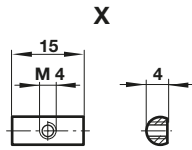
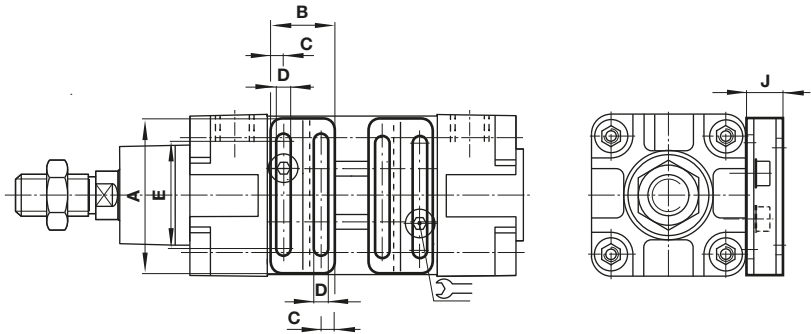
 Dimensions in mm
 Projection/First angle

Valve mounting kit

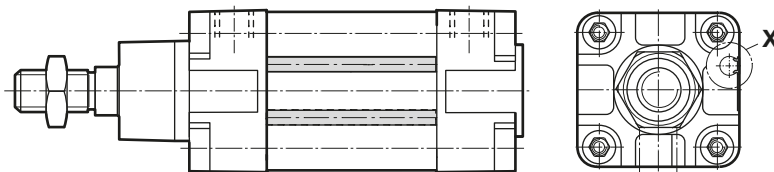
Ø	A	B	C	D	E	F	G	H	J	kg	Model
50/63	60	37	7	4,5	46	8,5	5,5	2	12	3	0,02 QA/180050/22/54
80/100	90	37	7	4,5	76	8,5	6,5	2	12	3	0,02 QA/180080/22/54

Groove cover M/P72725/1000

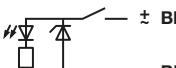
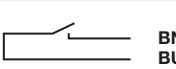
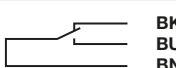
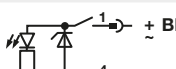
Technical data - Reed switches - additional informations see data sheet N/en 4.3.005

Symbol	Voltage		Current maximum (mA)	Function	Operating temperature (°C)	LED	Protection class	Plug	Cable length (m)	Cable type	Weight (g)	Model
	(V a.c.)	(V d.c.)										
	10 ... 240	10 ... 170	180	Closer	-25 ... +80	•	IP66	—	2, 5 or 10	PVC 2 x 0,25	37	M/50/LSU*V
	10 ... 240	10 ... 170	180	Closer	-25 ... +80	•	IP66	—	5	PUR 2 x 0,25	37	M/50/LSU/5U
	10 ... 240	10 ... 170	180	Closer	-25 ... +150	—	IP66	—	2	Silicon 2 x 0,25	37	TM/50/RAU/2S
	10 ... 240	10 ... 170	180	Changeover	-25 ... +80	—	IP66	—	5	PVC 3 x 0,25	37	M/50/RAC/5V
	10 ... 60	10 ... 60	180	Closer	-25 ... +80	•	IP66	M8 x 1	0,3	PVC 3 x 0,25	16	M/50/LSU/CP *1)

* Insert cable length; *1) Plug-in connector see page 11; Color code: BK = black, BN = brown, BU = blue

Drawings

M/50/LSU*V, M/50/LSU/5U,
 TM/50/RAU/2S
 Cable length L = 2, 5 or 10 m

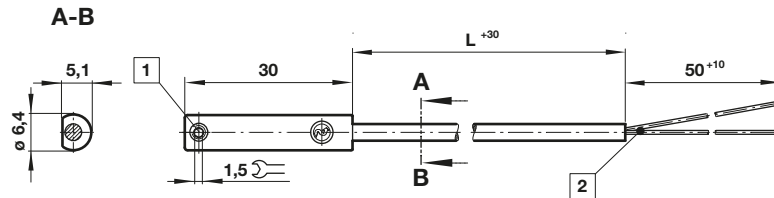

M/50/RAC/5V
 Cable length L = 5 m

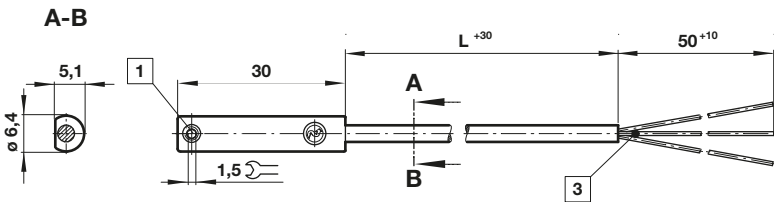

M/50/LSU/CP

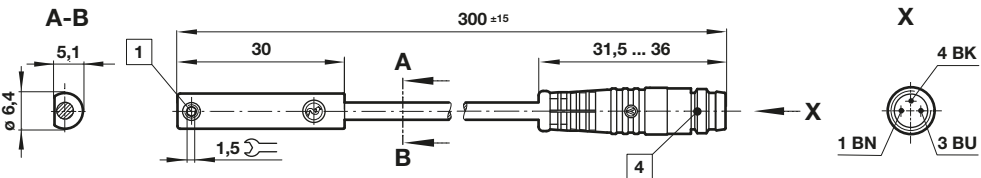

- 1 Fixing screw
- 2 + BN = brown; - BU = blue (output)
- 3 - BK = black; + BN = brown; - BU = blue
- 4 Plug M8 x 1, color code: BK = black; BN = brown; BU = blue

Dimensions in mm
 Projection/First angle



Switch mounting brackets - Brackets > 15 mm stroke

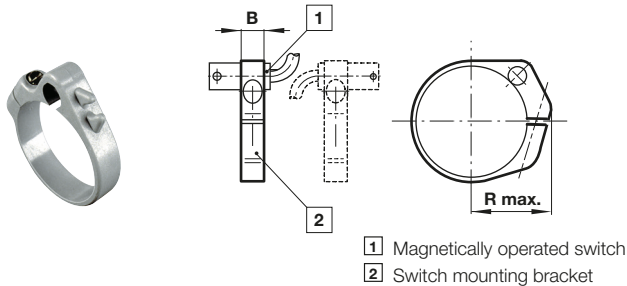

Switch mounting brackets - Brackets < 15 mm stroke

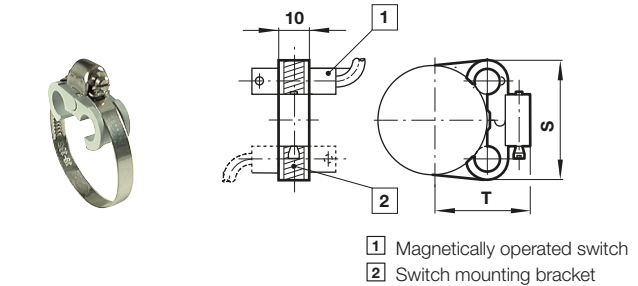

Ø	B	R max.	kg	Model
10	8	16	0,01	QM/33/010/22
12	8	18	0,01	QM/33/012/22
16	10	20	0,01	QM/33/016/22
20	10	22	0,01	QM/33/020/22
25	10	24	0,01	QM/33/025/22

Ø	S	T	kg	Model
10	27,5	19,5	0,01	QM/33/010/23
12	28,5	21,5	0,01	QM/33/016/23
16	29,5	23,5	0,01	QM/33/016/23
20	29,5	26	0,01	QM/33/020/23
25	31,5	28,5	0,01	QM/33/025/23

Technical data - Solid state - additional informations see data sheet N/en 4.3.007

Symbol	Voltage (V d.c.)	Current maximum (mA)	Function	Operating temperature (°C)	LED	Protection class	Plug	Cable length (m)	Cable type	Weight (g)	Model
	10 ... 30	150	PNP	-40 ... +80	•	IP67	—	2, 5 or 10	PVC 3 x 0,12	37	M/50/EAP/*V
	10 ... 30	150	PNP	-40 ... +80	•	IP68	—	5	PUR 3 x 0,14	37	M/50/EAP/5U
	10 ... 30	150	PNP	-40 ... +80	•	IP67	M8 x 1	0,3	PVC 3 x 0,14	16	M/50/EAP/CP *1)
	10 ... 30	150	PNP	-40 ... +80	•	IP67	M12 x 1	0,3	PVC 3 x 0,14	16	M/50/EAP/CC *1)
	10 ... 30	150	NPN	-40 ... +80	•	IP67	—	2, 5 or 10	PVC 3 x 0,12	37	M/50/EAN/*V
	10 ... 30	150	Closer	-40 ... +80	•	IP67	M8 x 1	0,3	PVC 3 x 0,14	16	M/50/EAN/CP *1)

* Insert cable length; *1) Plug-in connector below; Color code: BK = black, BN = brown, BU = blue

Drawings

M/50/EAP/*V,
M/50/EAN/*V
Cable length L = 2, 5 or 10 m

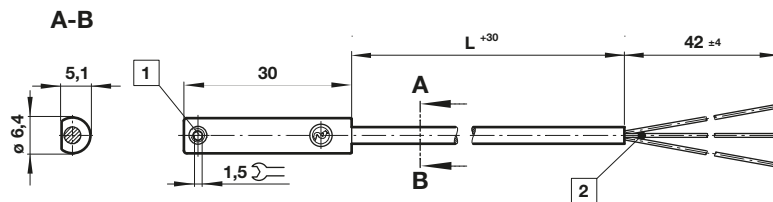

Dimensions in mm
Projection/First angle



M/50/EAP/CP,
M/50/EAN/CP

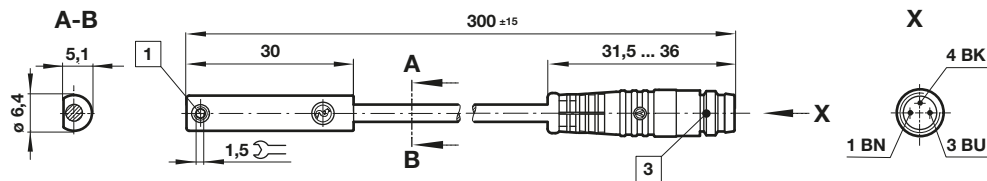

M/50/EAP/CC

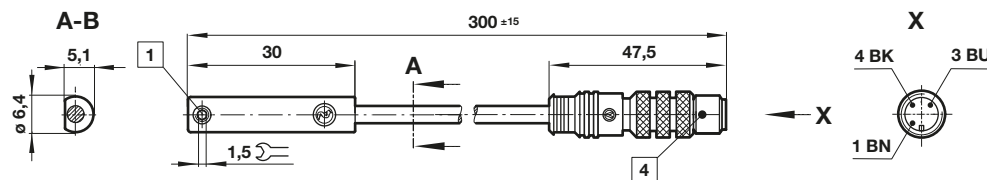

- 1 Fixing screw
- 2 Color code: BK = black; BN = brown; BU = blue
- 3 Plug M8 x 1
- 4 Plug M12 x 1

Accessories

Plug-in connector cable with nut



Outer cover	Cable length (m)	Weight (kg)	Connector	Connector
PVC 3 x 0,25	5 m	0,18	M8 x 1	M/P73001/5
PUR 3 x 0,25	5 m	0,18	M8 x 1	M/P73002/5
PUR 3 x 0,34	5 m	0,21	M12 x 1	M/P34594/5

Warning

These products are intended for use in industrial compressed air systems only. Do not use these products where pressures and temperatures can exceed those listed under

»Technical features/data«.

Before using these products with fluids other than those specified, for non-industrial applications, life-support systems or other applications not within published specifications, consult IMI Precision Engineering, Norgren GmbH. Through misuse, age, or malfunction, components used in fluid power systems can fail in various modes.

The system designer is warned to consider the failure modes of all component parts used in fluid power systems and to provide adequate safeguards to prevent personal injury or damage to equipment in the event of such failure.

System designers must provide a warning to end users in the system instructional manual if protection against a failure mode cannot be adequately provided.

System designers and end users are cautioned to review specific warnings found in instruction sheets packed and shipped with these products.